

EXPLODED VIEW 23CIII CHASSIS

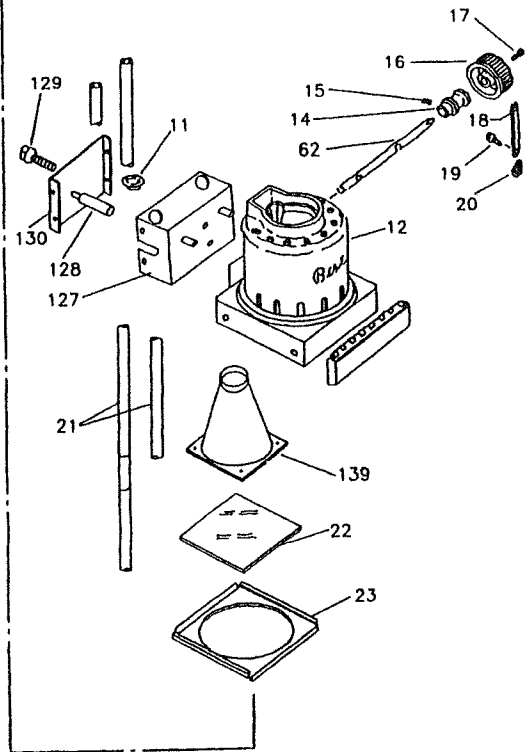
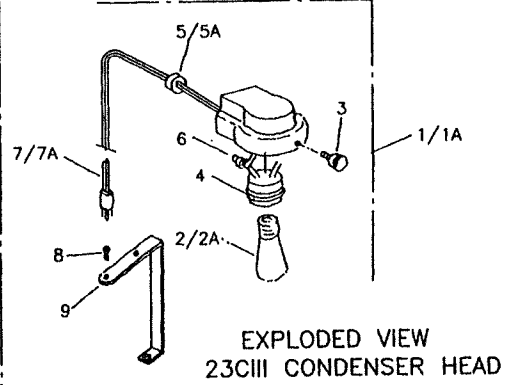
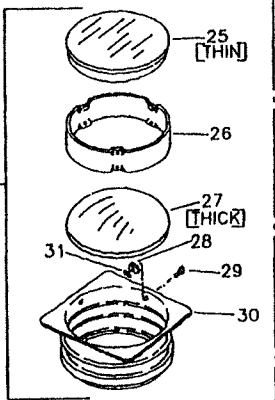
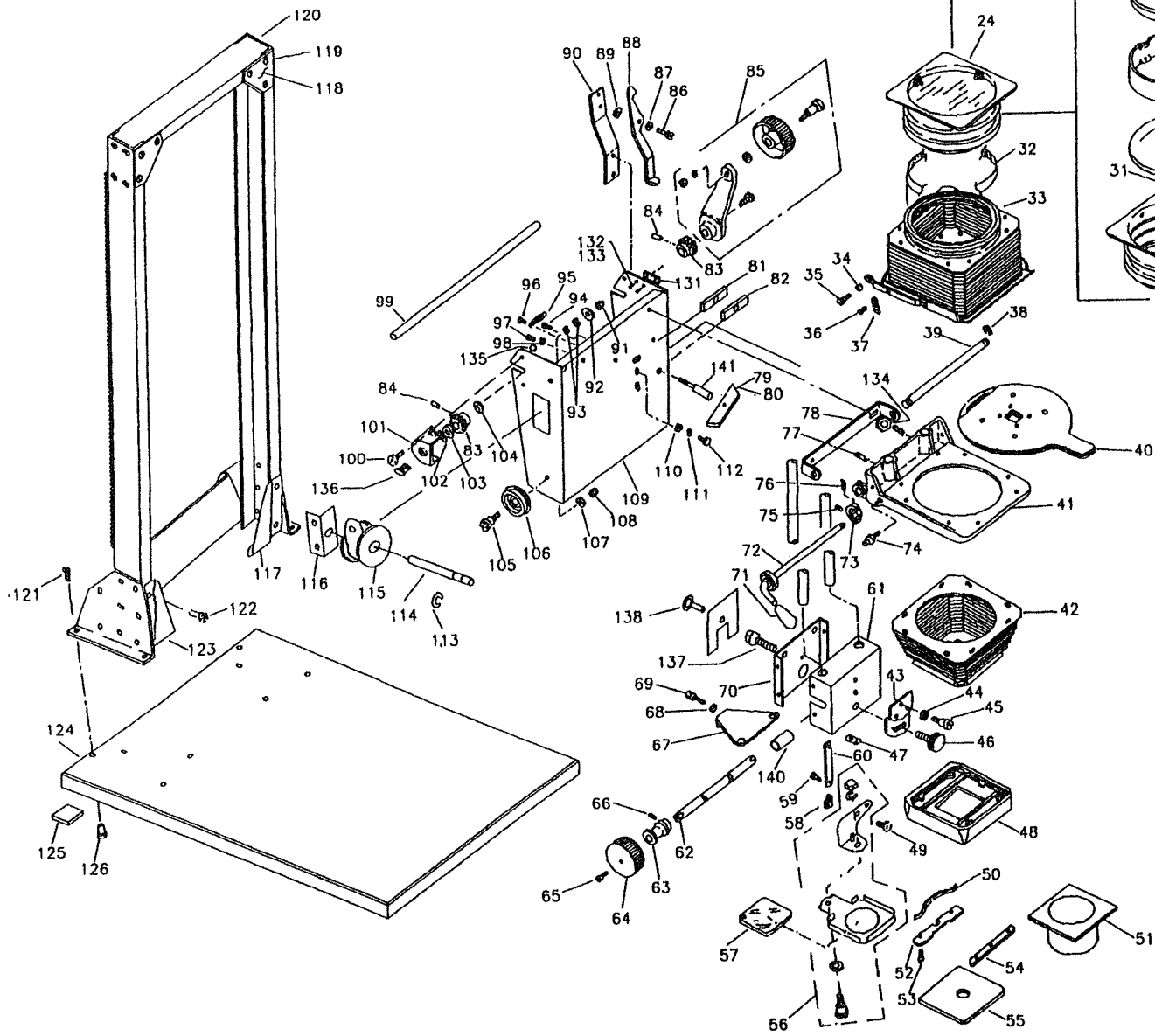

## 23C III-XL PARTS LIST

REF. NO.	DESCRIPTION	PART/CAT. NO.	REF. NO.	DESCRIPTION	PART/CAT. NO.	REF. NO.	DESCRIPTION	PART/CAT. NO.
1	Lamp Cap Assembly	10-43755-15	46	Knob	568-20-05	94	Screw, Tapp 6Bx <sup>3</sup> / <sub>16</sub> Lg.	538-19-06-08
1A	Lamp Cap Assembly (240V)	10-43755-20	47	Indicator	10-07628	95	Spring, Wire .218OD	562-70-14
2	Lamp, PH140	8101	48	Lens Stage	10-44052	96	Screw, Machine 10-32x <sup>3</sup> / <sub>16</sub> Lg.	524-06-02-01
2A	Lamp, PH1400 (240V)	8114	49	Screw, Machine 6-32x <sup>5</sup> / <sub>16</sub> Lg.	521-10-02-01	97	Screw, Machine 10-32x <sup>3</sup> / <sub>8</sub> Lg.	524-12-02-01
3	Knob	568-20-05	50	Spring	10-04543	98	Lockwasher, #10	549-40-15
4	Lamp Socket	625-82-07	51	Lens Extension	Accessory	99	Shaft	10-44051
5	Strain Relief	600-82-30	52	Rear Retainer	10-04542	100	Screw, #8-32x <sup>1</sup> / <sub>2</sub> Lg.	521-16-02-05
5A	Strain Relief (240V)	600-82-25	53	Screw, Tapp 4BTx <sup>3</sup> / <sub>8</sub> Lg.	538-13-12-31	101	Guard	10-07680-03
6	Wire Nut	600-25-22	54	Forward Retainer	10-44056	102	Bow Washer, <sup>25</sup> / <sub>64</sub> IDx <sup>5</sup> / <sub>8</sub> ODx <sup>3</sup> / <sub>32</sub> H	549-20-27
7	Cord Set	10-43748	55	Lensboard	Accessory	103	Washer, .3771Dx.792ODx.031	548-46-16
7A	Cord Set (240V)	10-43743	56	Filter Holder Assembly	10-43758	104	Washer, <sup>25</sup> / <sub>64</sub> IDx <sup>3</sup> / <sub>4</sub> ODx <sup>1</sup> / <sub>16</sub> (2 pcs.)	548-48-13
8	Screw, Machine <sup>1</sup> / <sub>4</sub> -20x <sup>3</sup> / <sub>8</sub> Lg.	527-12-02-01	57	Filter, Safety	8040	105	Shoulder Screw, 10-32x <sup>5</sup> / <sub>64</sub>	540-30-28
9	Indicator, Negative Size	10-07684	58	Speed Nut, U-Type 6-32 Tinn	555-05-31	106	Roller	10-07606
11	Bushing, Snap .562 Mount	570-50-33	59	Screw, Mach 6-32x <sup>3</sup> / <sub>4</sub>	519-24-02-01	107	Washer, 10x <sup>1</sup> / <sub>2</sub> OD	548-24-09
12	Lamp Housing Assembly	10-54642	60	Tension Spring	10-07650	108	Nut, Lock Hex 10-32	546-57-13
14	Friction Wheel	10-07651	61	Lower Housing	10-07649-03	109	Cross Carriage	10-07626
15	Set Screw, Headless 8-32x <sup>3</sup> / <sub>16</sub>	540-20-60	62	Shaft	10-07652	110	Washer, 10x <sup>1</sup> / <sub>2</sub> OD	548-24-09
16	Knob	568-05-07	63	Friction Wheel	10-07651	111	Lockwasher #10	549-40-15
17	Screw, Machine 6-32x <sup>1</sup> / <sub>2</sub> Lg.	519-16-02-01	64	Knob	568-05-07	112	Screw, 10-24x <sup>3</sup> / <sub>8</sub> Lg.	523-12-60-02
18	Tension Spring	10-07650	65	Screw, Mach 6-32x <sup>1</sup> / <sub>2</sub> Lg.	519-16-02-01	113	Retaining Ring, E Type	555-26-14
19	Screw, Machine 6-32x <sup>3</sup> / <sub>4</sub> Lg.	519-24-02-01	66	Set Screw, Headless 8-32x <sup>3</sup> / <sub>16</sub>	540-20-60	114	Shaft, Spring Drum	10-43722
20	Speed Nut, U-Type 6-32 Tinn	555-05-31	67	Vertical Stop	10-07645	115	Constant Force Spring Assembly	10-43718
21	Guide, Rod	10-44057-01	68	Nut, Hex <sup>1</sup> / <sub>4</sub> -20	545-27-20-01	116	Bracket, Spring Drum Mounting	10-43723
22	Heat Absorber Glass (Accessory)	8042	69	Screw, Machine <sup>1</sup> / <sub>4</sub> -20x1- <sup>1</sup> / <sub>2</sub> Lg.	527-48-40-45	117	Gusset, Lower Frame (R. H.)	10-43726-02
23	Filter Holder	10-07685	70	Cover	10-54644	118	Gusset, Upper Frame	10-07746
24	Condenser Assembly	10-07662	71	Knob	568-40-06	119	Screw, Tapp 8Bx <sup>3</sup> / <sub>8</sub> Lg.	538-21-12-06
25	Condenser, Upper	680-14-45	72	Stage Opening Lever	10-07630	120	Frame Assembly	10-43717
26	Spacer	10-07664	73	Cam	7000	121	Screw, Machine <sup>1</sup> / <sub>4</sub> -20x <sup>7</sup> / <sub>8</sub> Lg.	527-28-32-01
27	Condenser, Lower	680-22-07	74	Stud	10-04613-01	122	Screw, Tapp 10Bx <sup>5</sup> / <sub>16</sub> Lg.	538-23-10-02
28	Pad	10-07665	75	Set Screw, Headless 6-32x <sup>3</sup> / <sub>16</sub>	540-20-13	123	Gusset, Lower Frame (L. H.)	10-43726-01
29	Screw, Tapp 4Bx <sup>3</sup> / <sub>8</sub> Lg.	538-13-12-30	76	Set Screw, Headless 6-32x <sup>3</sup> / <sub>8</sub>	540-20-17	124	Baseboard	10-43728-02
30	Condenser Housing	10-07663	77	Set Screw, Headless <sup>1</sup> / <sub>4</sub> -20x <sup>5</sup> / <sub>16</sub>	540-22-52	125	Pad, Baseboard	10-42018
31	Speed Nut, Flat 4Z Tinn	555-01-03	78	Bracket	10-54628	126	Tee Nut, Propeller <sup>1</sup> / <sub>4</sub> -20	546-40-15
32	Light Seal	10-07661	79	Knob	568-99-01	127	Upper Housing	10-54635
33	Upper Bellows Assembly	10-07658	80	Set Screw #8-32x <sup>3</sup> / <sub>16</sub>	540-22-79	128	Spacer	557-21-53
34	Bow Washer, <sup>1</sup> / <sub>4</sub> IDx <sup>1</sup> / <sub>2</sub> ODx <sup>3</sup> / <sub>32</sub> H	549-20-17	81	Bar, Clamping	10-53790-01	129	Screw <sup>5</sup> / <sub>16</sub> -18x2 <sup>1</sup> / <sub>2</sub>	527-80-40-02
35	Shoulder Screw, 10-24x.406 Lg.	540-30-46	82	Bar, Clamping	10-53790-02	130	Cover	10-54645-02
36	Screw, Tapp 6Bx <sup>1</sup> / <sub>4</sub> Lg.	538-19-08-37	83	Gear }	Gear Replacement	131	Block	10-54629
37	Spring, Wire Ext. .173OD	562-70-09	84	Roll Pin }	Kit 7002	132	Screw #8-32F	538-21-16-23
38	Retaining Ring, E Type <sup>3</sup> / <sub>8</sub> Shaft	555-26-14	85	Elevating Handle Assembly	7003	133	Washer #8	548-22-02
39	Shaft	10-07679	86	Shoulder Screw, 10-24x.380 Lg.	540-30-12	134	Eccentric Nut	546-80-10
40	Negative Carrier	Accessory	87	Bow Washer <sup>17</sup> / <sub>64</sub> IDx <sup>9</sup> / <sub>16</sub> ODx <sup>1</sup> / <sub>16</sub> H	549-20-18	135	Nut #8-32	546-55-06
41	Lower Negative Stage	10-07642	88	Latch	10-07612	136	Bearing	560-50-40
42	Lower Bellows	10-07653	89	Washer, 10x <sup>1</sup> / <sub>2</sub> OD	548-24-09	137	Alignment Screw	540-80-15
43	Tilt Plate	10-07627	90	Stop	10-07609	138	Screw, #8-32x <sup>5</sup> / <sub>16</sub> Lg.	521-10-02-01
44	Bow Washer, <sup>21</sup> / <sub>64</sub> IDx <sup>9</sup> / <sub>16</sub> ODx <sup>1</sup> / <sub>8</sub> H	549-20-25	91	Lock Nut, Hex 10-32	546-57-13	139	Baffle-Light	10-07672-02
45	Shoulder Screw, <sup>1</sup> / <sub>4</sub> -20x.642 Lg.	540-30-57	92	Washer, 10x <sup>3</sup> / <sub>4</sub> OD	548-24-29	140	Cap	570-42-71
			93	Lockwasher, #10	549-40-15	141	Clamp Screw	10-54638